

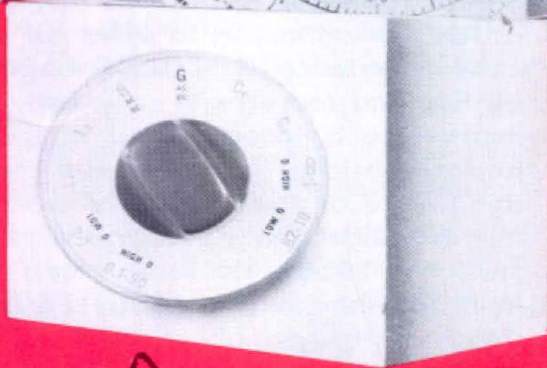

THE GENERAL RADIO

Experimenter

- * AN AC-DC DVM
- * A NEW UNIVERSAL IMPEDANCE BRIDGE

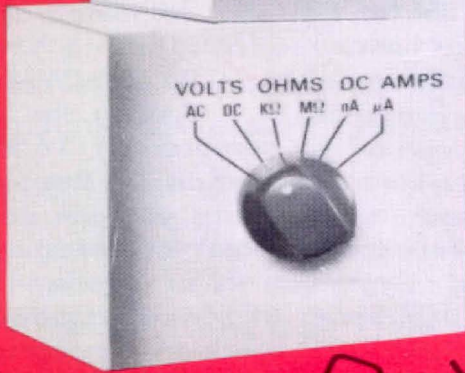
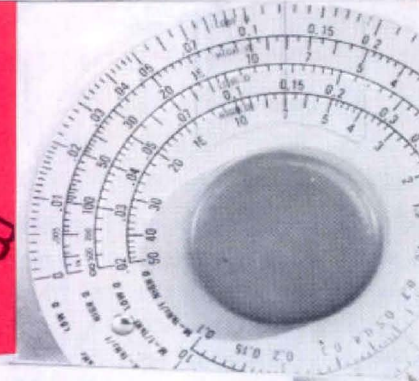
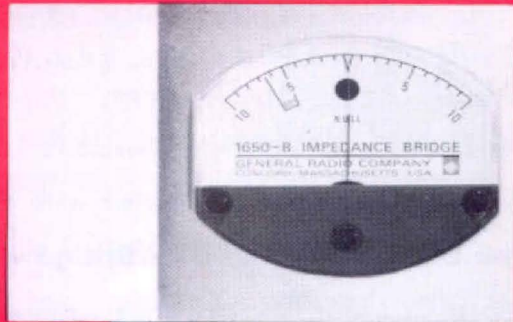

ALSO IN THIS ISSUE:

- AN EXERCISE IN VOLTAGE DIVISION
- NEW COAXIAL CAPACITANCE STANDARDS

VOLUME 42 · NUMBER 5 / MAY 1968

the Experimenter

Volume 42 • No. 5 May 1968

Published monthly by the General Radio Company

© 1968 — General Radio Company, West Concord, Mass., USA

CONTENTS

	Page
An Exercise in Voltage Division	3
A Versatile Digit Multimeter with dB Readout	8
The Universal Impedance Bridge—New Face, New Features	15
More Coaxial Capacitance Standards	19

ABOUT THIS ISSUE

When you specify voltage ratio to an accuracy of 0.2 part per million, as we do for our precision decade transformers, it is reasonable for people to ask how you can be so sure. In answer, Henry Hall conducts "An Exercise in Voltage Division" in this month's feature article. . . . Is it too much to expect a single digital voltmeter to be a dc multimeter, a uhf (to 1.5 GHz) voltmeter, and an ac/dc millivoltmeter, to offer dB as well as linear readouts, and to have an input impedance of 100,000 megohms on all ranges? No. GR's first DVM does all this and more, with only two plug-ins (page 8). . . . Among the many improvements incorporated in the latest version of our popular 1650 impedance bridge (page 15) is a conductance-measuring capability. Even if you don't have any conductors you want to measure, the things you can do with ac resistance and conductance measurements should whet your imagination. The new 1650 also looks nicer, is priced lower than its predecessor. . . . With the introduction of the 1405 and 1407 series of coaxial capacitance standards (page 19), the benefits of the GR900[®] precision connector are applied to standards from 1 pF to 0.1 μ F. These benefits include accuracy, repeatability, and traceability to NBS.

The *General Radio Experimenter* is mailed each month without charge to engineers, scientists, technicians, educators, and others interested in the instruments and techniques of electrical and electronics measurements. Address all correspondence to Editor, *General Radio Experimenter*, General Radio Co., West Concord, Mass. 01781.

AN EXERCISE IN VOLTAGE DIVISION

Voltage ratio, being dimensionless, has no legal unit and no national standard. While resistance, mass, voltage, etc are all defined in terms of standards kept by national laboratories, anyone can make ratio measurements and claim any accuracy he feels his equipment and technique have given him. Whether or not anyone will believe him is, of course, another matter.

The GR 1493 Precision Decade Transformer can easily be read to one part-per-billion* (ppb) of input. At reasonable frequencies and voltages, ac ratio-measuring systems have sensitivities of this order, and comparisons on dividers can be repeated to better than 10 ppb of input, even to 1 ppb on successive measurements. Using two of these dividers and reversing one with respect to the other, one can determine the correction for the 0.5 point repeatedly to within a few ppb.

With resolution and sensitivity available and with confidence that we knew one point very accurately, it took more restraint than we possessed not to try to get the remaining steps of 1/10 input.

CHOICE OF METHOD

The results of any one determination of ratio would not be of too much use. We'd never really know how close we were, and analysis of all possible errors would take years. Therefore, we decided to use three completely different methods and to see how they compared.

Many methods have been used for ratio measurement. We wanted to use those that offered the greatest accuracy as well as those that used the least special equipment. We ruled out all

* An American billion, or 10^9 , not an English billion (10^{12})

methods using resistors, even though these can be quite accurate under certain conditions. At 1 kHz and 100 volts, where we wanted to work, low-valued resistors dissipate too much power and thus change value, and high-valued resistors exhibit too much phase shift.

The three methods we decided on were (1) the cyclic capacitor method of Cutkosky and Shields,¹ (2) the "bootstrap" method of Sze,² and (3) a "straddling" method based on the common reversing technique.

Cyclic Capacitor Method

This method was chosen because Cutkosky and Shields¹ had such good results: 4 ppb at 50% confidence for a 10:1 ratio. While we didn't plan to duplicate their equipment, as a manufacturer of reference standard capacitors we do have a lot of these available, and this method requires good capacitors. The decade transformer is compared with a capacitive divider, or rather to several capacitive dividers, for each capacitor is used in both halves of the divider, and the average of all measurements is taken. The beauty of the method lies in its mathematics. As an example, take the 3:1 divider shown in Figure 1. If each capacitor in turn is connected to the high input and the others to the low, the average of the three ratios is:

$$\frac{1}{3} \left(\frac{C_1}{C_1 + C_2 + C_3} + \frac{C_2}{C_1 + C_2 + C_3} + \frac{C_3}{C_1 + C_2 + C_3} \right) = \frac{1}{3} \quad (1)$$

All that is required is that the capacitors maintain their values during the cycle of measurement. This means that

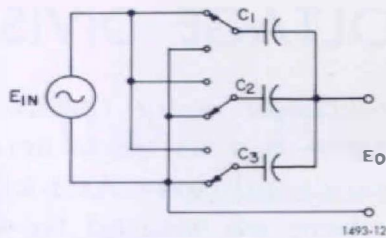

Figure 1. Simplified diagram of capacitive divider using only three capacitors.

output impedance is low, (2) the stray capacitances form a divider of almost the same ratio, and (3) the cyclic rotation of capacitors rotates these strays also so that this source of error is also averaged out.

they must have low temperature coefficients and that the measurements must be made in a well controlled room.

For our measurements, 10 capacitors were used. For odd values except 0.5, 10 separate measurements had to be made; for even values, five measurements will do (switching two capacitors at a time); at the 0.5 point only two measurements are necessary.

The circuit diagram for these measurements is shown in Figure 2. It should be noted that the capacitors (TYPE 1404-A, 1000 pF) are three-terminal and have appreciable capacitance from each terminal to case. At first we tried to use a separate guard divider to adjust the case potential as a preliminary balance, but the balance of such a guard was extremely critical. Therefore, we tied this point directly to the output of the divider under test. This causes negligible loading error because (1) the

The only special equipment required was the special switch box to connect the low side of each capacitor to either the high or low side of the input. This box requires no special internal shielding and is very easy to make. Unfortunately, many laboratories may not have ten 1404-A capacitors.

The Bootstrap Method

This method uses a shielded, 10:1 transformer as a yardstick to measure each step of one-tenth input. While this yardstick may not be completely accurate, we know that the sum of the 10 steps must be unity. This extra condition gives the extra equation necessary to determine all voltages. Putting this into algebra instead of words, we have, from Figure 3:

$$E_n - E_{n-1} = \delta + E_y, \quad (2)$$

and because the input is unity by definition:

CYCLIC CAPACITOR METHOD

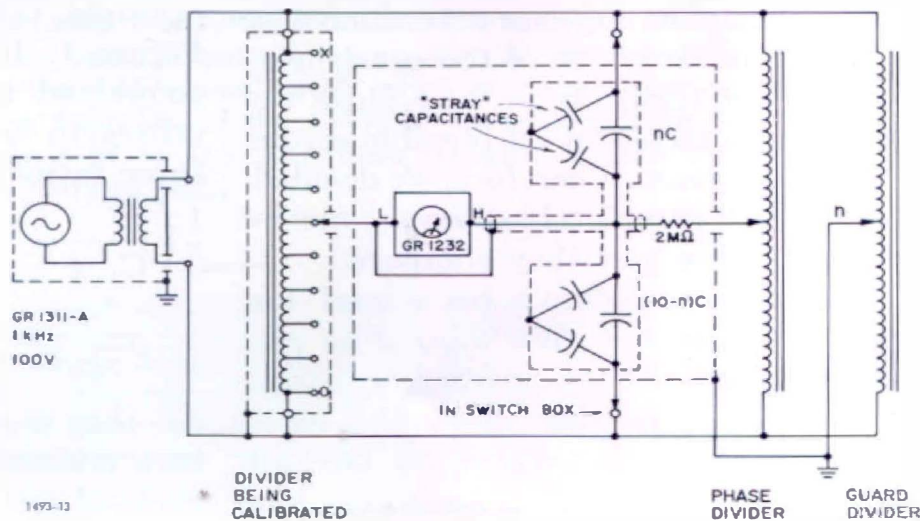

Figure 2. Connection diagram for "cyclic capacitor" method (note: n = number of tenths of input).

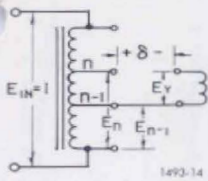

Figure 3. Basic principle of "bootstrap" method, where E_y is the voltage obtained from the shielded 10:1 transformer.

$$10E_y + \sum_{j=1}^{10} \delta_j = 1, \quad (3)$$

from which

$$E_y = \frac{1}{10} \left(1 - \sum_{j=1}^{10} \delta_j \right). \quad (4)$$

To find the value of each step, we add up all voltages from zero, or:

$$E_n = \sum_{k=1}^n \delta_k + nE_y = \frac{n}{10} + \sum_{k=1}^n \delta_k - \frac{n}{10} \sum_{j=1}^{10} \delta_j. \quad (5)$$

In actual dividers, the voltage difference between the 0 and full-scale settings is not equal to the input voltage because of voltage drop in the wiring. Therefore, the input voltage must be measured at the high and low input terminals if expression (3) above is to be valid. The corrections for the 0 and \times (10) positions can easily be determined from the small difference between these settings and the input terminals.

While in theory the voltage, E_y , could be any value, it is highly desirable that it be as nearly equal to one-tenth as possible, so that all differences will be small for accurate measurement and so that changes in the E_y error will not be important. This transformer must be doubly shielded; we want E_y to be independent of ratio setting, and this would not be so if there were capacitances to either winding from variable voltages. We first used a simple shielded

toroidal transformer, which had an error of about 30 ppm (30,000 ppb) of input. This would not have been too bad if it was very constant, but unfortunately this ratio depended heavily on input voltage. A better transformer was required.

In his paper on this method Sze used a "two-stage transformer" as described by Brooks and Holtz³ and by Cutkosky⁴. Such a circuit greatly reduces the error due to voltage drop in the primary by sampling the flux and adding additional voltage. The full input voltage in Figure 4 is applied to winding #1. However, because of the voltage drop due to z_1 , e_2 and e_3 are slightly low. The difference between e_{in} and e_2 is applied to a second transformer whose output is added to e_3 as a correction.

The transformer we used, shown in cross-section in Figure 5, was constructed quite differently from Sze's. Two of these transformers were made, and both had ratio errors of less than 20 ppb of input (or 200 ppb of output). Note that the outer winding of the two

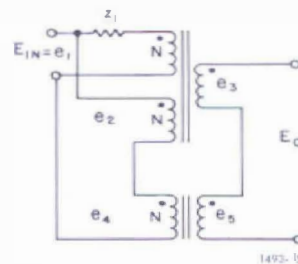

Figure 4. Simplified diagram of "two-stage" transformer, which is actually two transformers interconnected.

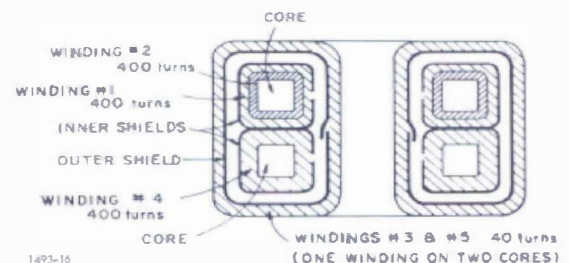
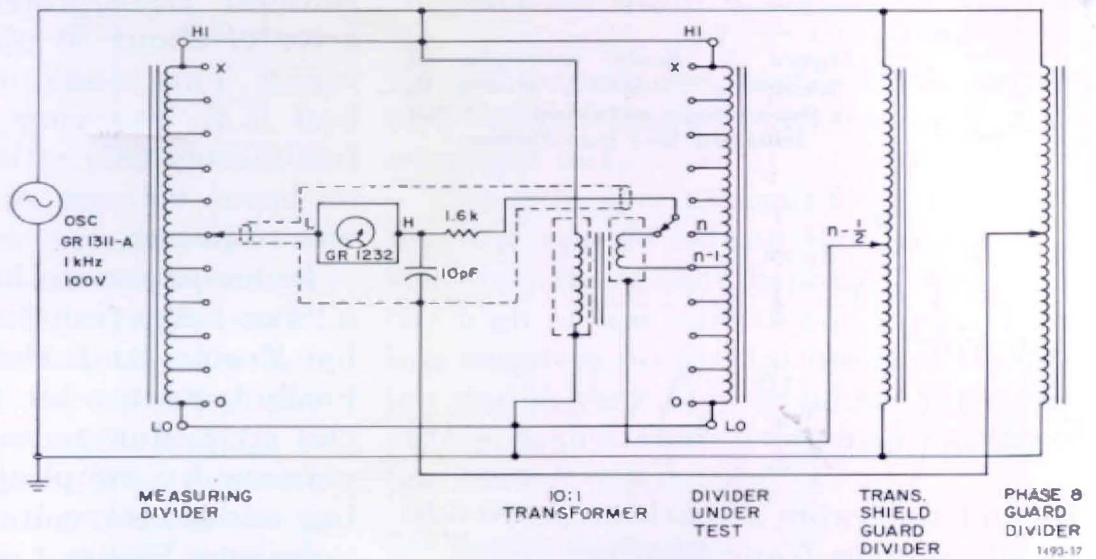

Figure 5. Cross-section diagram of "two-stage" transformer. Note two toroidal cores used.

BOOTSTRAP METHOD

Figure 6. Connection diagram for "bootstrap" method. (Note: n = number of tenths of input. At midpoint $n = 5$ and $n - \frac{1}{2} = 4.5$, which is a ratio of 0.45).



windings on the upper core is used as winding #1 because it has more nearly equal coupling to output (#3) and to sampling winding (#2) than the inner winding has.

This bootstrap method was the easiest to use. Measurements and calculations for all 1/10 steps could be made easily in one hour. The complete circuit diagram is shown in Figure 6. The special transformer is not too difficult to make, particularly if a toroidal winding machine is available.

The Straddling Method

As said before, the correction for the 0.5 point can be easily found by reversal of one divider with respect to another. By continuing such division, one can get $\frac{1}{4}$ points, then $\frac{1}{8}$ points, etc (see Zapf⁵). Unfortunately, most dividers are decade rather than binary, so this subdivision is not suitable. However, if one knows the ratio between all pairs of adjacent decade steps, it is possible to calculate the correction for each step. These ratios can be determined by the use of another decade transformer straddling each pair of two 1/10 steps (see Figure 7).

The algebra necessary to determine the expression for any point is tiresome (though not difficult), and so it will not be repeated here. The arithmetic required to evaluate each point after measurement is also dreary, so we programmed a computer to do the job for us.

The circuit diagram is shown in Figure 8. Several points are worthy of note:

1. The divider being tested has to have all its 1/10 steps brought out. While it would be possible to bring out the taps of a commercial divider, we made a special divider using the first transformer from a GR 1493.
2. The correction for the straddling divider at the 0.5 point is determined by reversal of its leads.
3. The straddling divider loads the divider under test. In practice, the resulting error is almost negligible. The magnitude of the change caused by

Figure 7. Principle of "straddling" method.

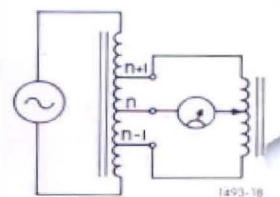

STRADDLING METHOD

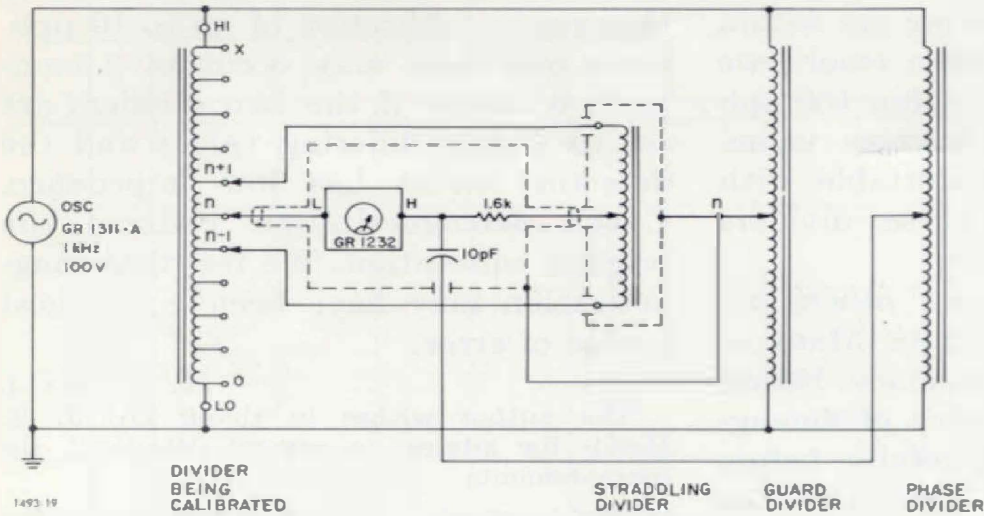

Figure 8. Connection diagram of "straddling" method.

loading was measured by the addition of still another divider in parallel with the straddling divider, and the resulting change of setting was used as a correction.

4. The high and low input terminals should be used for the measurement, instead of the X and 0 points, so that the total voltage is unity by definition.

RESULTS

Figure 9 shows the measured corrections for GR 1493, Serial No. 110, made by two runs using each method. Note that the worst spread of points is less than 30 ppb. Many more runs have been made by the bootstrap method, and they all fell within this spread. Also in this plot is the 0.5 point determined by simple reversal. Its location is reassuring.

We are somewhat hesitant to place a number on our uncertainty because of the clamor this usually raises from statisticians. We prefer to let the results speak for themselves. However, we feel quite confident that the average of these measurements is within 20 ppb of the true ratio. Some readers may disagree with this conclusion and argue

that all three methods could be wrong in the same direction, which could be true. Maybe someday we'll try still another method or two to see how they come out.

An independent check is our NBS calibration, even though the Bureau claimed only 200 ppb of input.* The NBS values differ by as much as 50

* NBS Boulder. They no longer make these measurements.

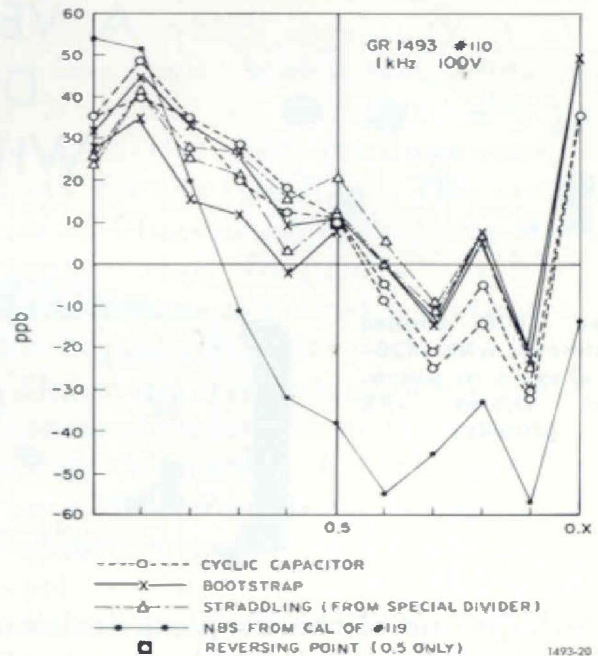

Figure 9. Results of six calibrations, two using each method. Correction in parts-per-billion plotted vs ratio.

ppb from our average value. We have complete confidence that we are within 50 ppb of true value. As a result, we now check 1493's to be within 150 ppb of both NBS and our average value. We thus feel quite comfortable with our specifications for these dividers (± 200 ppb of true ratio).

One note of advice for others attempting such measurements. Many of the measurements were made before we realized the importance of demagnetizing the dividers carefully before measurement. In some cases, previous overloads (removed at peak current)

caused magnetization that resulted in changes in calibration of up to 10 ppb. Such overloads may occur in a comparison circuit if the two dividers are set to widely differing values and the detector circuit has low impedance. Cyclic demagnetization restores the original calibration. We feel that magnetization may have been our largest source of error.

— H. P. HALL

The author wishes to thank Dr. J. F. Hersh for advice on several details of the measurements

A brief biography of Mr. Hall appeared in the June, 1966 *Experimenter*.

REFERENCES

- ¹ R. D. Cutkosky and J. Q. Shields, "The Precision Measurement of Transformer Ratios," *IRE Transactions on Instrumentation*, Vol. 1-9 No. 2, September 1960, p. 243.
- ² W. C. Sze, "An Injection Method for Self-Calibration of Inductive Voltage Dividers," *NBS Journal of Research, Section C*, January-March 1968.
- ³ H. B. Brooks and F. C. Holtz, "The Two-

Stage Current Transformer," *AIEE Transactions*, Vol 41, June 1922, pp 382-393.

⁴ R. D. Cutkosky, "Active and Passive Direct-Reading Ratio Sets for the Comparison of Audio-Frequency Admittances," *IEEE Transactions on Instrumentation and Measurement*, Vol IM-13, No. 4, December 1964, pp 243-250.

⁵ T. L. Zapf, "The Calibration of Inductive Voltage Dividers," *ISA Transactions*, Vol. 2 No. 3, July 1963, p 195.

A VERSATILE DIGITAL MULTIMETER WITH dB READOUT

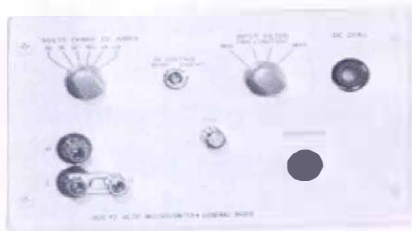

Type 1820 Digital Voltmeter, with 1820-P1 plug-in in place. Inset shows -P2 plug-in.



Perhaps one of the simplest decisions an instrument user should have to make is which digital voltmeter to buy. This is usually true if one is concerned pri-

marily with dc voltage measurements. For as soon as one specifies the desired dc accuracy, the choice is usually limited to a group of instruments, and

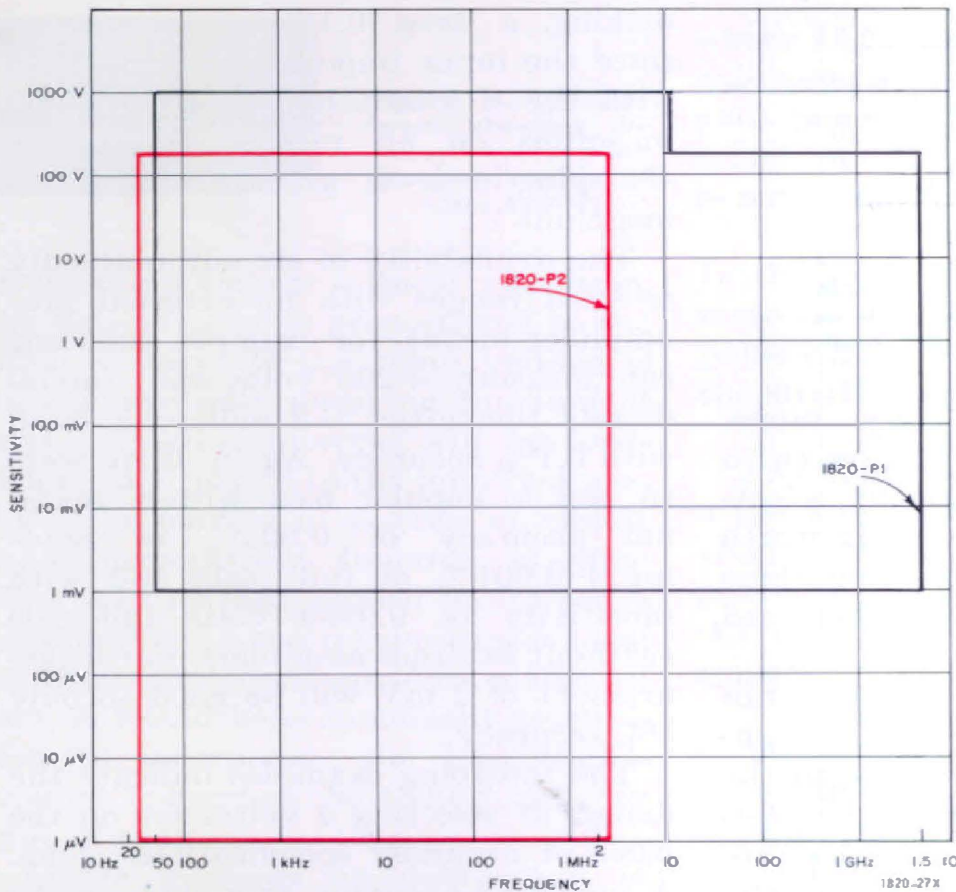

Figure 1. Voltage and frequency range of the 1820 DVM with each of its plug-ins.

one then need only select a unit out of this group to meet his other requirements.

Digital voltmeters are also becoming increasingly useful in the field of ac measurements. Here, however, the choice is more difficult, because many of the features that one would normally seek in an ac meter have, until now, not been available in a digital instrument. General Radio has addressed its first digital voltmeter, the TYPE 1820, to this lack. Designed primarily for ac measurements, the 1820 will also measure dc voltage, resistance, and ac and dc currents.

The 1820 is available with either of two plug-ins, the 1820-P1 and the 1820-P2. Both are ac-dc plug-ins; the differences between them lie in their voltage and frequency ranges and are

seen at a glance in Figure 1. Which plug-in to use depends on whether one wants ultra-high sensitivity (1 μV for the last digit) and a frequency range to 2 MHz or ultra-high frequency (to 1.5 GHz) with medium sensitivity (1 mV for the last digit). This combination of plug-ins extends both the sensitivity and frequency ranges far beyond those achieved by other available digital voltmeters.

Direct dB readout, so often desired in ac measurements, is rather common on analog voltmeters, but rare on DVM's. The 1820 offers both linear and dB readouts, switch-selectable at the front panel.

As an ac voltmeter, the 1820 is obviously in a class by itself. As a dc voltmeter, it offers two features not now available in other DVM's. First, no at-

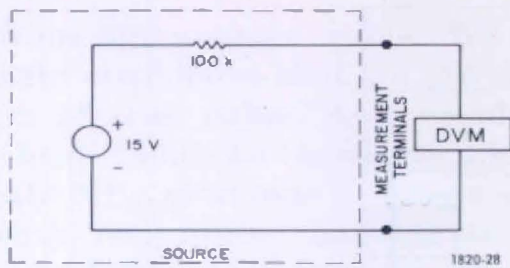

Figure 2. Input impedance of DVM is critical in measurement such as that indicated here (see text).

tenuator is used — on any range. Second, there are as many as six (with the -P2 plug-in) automatically selectable ranges on ac or dc. It is worth taking a few moments to see how these features are translated into increased accuracy of measurement.

One of the commonest errors a user of DVM's encounters, especially with high-impedance circuits, is that due to the finite input impedance of the voltmeter. For instance, suppose that we are about to measure a voltage of 15 volts dc, with a source impedance of 100 kilohms, to 0.1% accuracy (see Figure 2). If we use a popular DVM with a stated accuracy of 0.005% of reading, our measurement will really be accurate only to 1%, because the input impedance of this voltmeter, like that of most others on the market, is only 10 megohms above 10 volts. On the other hand, if we made the same measurement with the 1820 — with a 0.1% basic accuracy specification — we are

making a true 0.1% measurement, since the input impedance of the 1820 with the -P1 unit is at least 100,000 megohms on all ranges. (With the -P2 plug-in it is greater than 1000 megohms.)

The availability of six automatically selected ranges with no external pre-amplifier means, for example, that one can measure +200 volts and, immediately thereafter, -2 millivolts, both with 0.1% accuracy. Again, if we were to use a popular DVM with a nominal accuracy of 0.005% of reading + 0.001% of full scale and with sensitivity of 9.9999 volts full-scale (without external amplifier), our measurement of 2 mV will be good to only 1% accuracy.

The foregoing examples indicate the danger of selecting a voltmeter on the basis of accuracy specifications alone. A moderate-accuracy DVM such as the 1820 may in fact greatly outperform a high-accuracy instrument in many applications.

GENERAL DESCRIPTION

The 1820 is a ramp-type digital voltmeter, shown in generalized block-diagram form in Figure 3. The start pulse initiates the ramp and also starts the time interval. When the ramp voltage equals the input signal, the time interval ends and is indicated digitally.

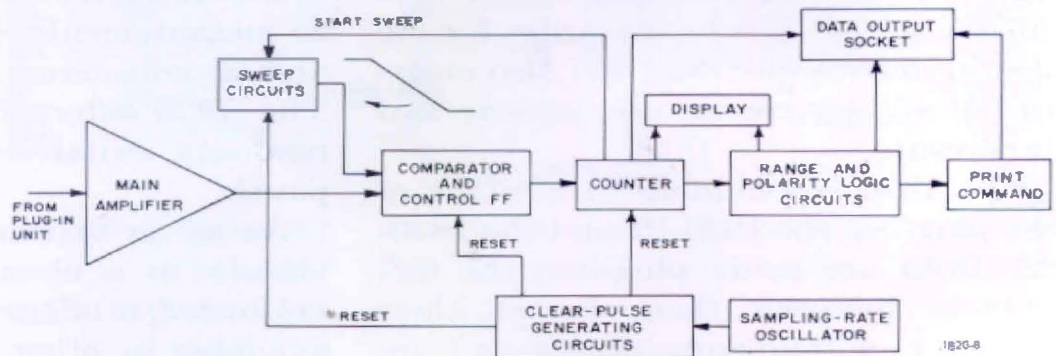

Figure 3. Simplified block diagram of the 1820.

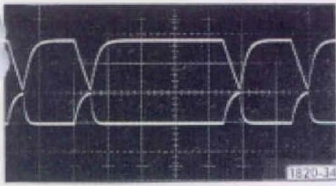

Figure 4. Oscilloscope showing the linear (top) and log (bottom) sweeps of the 1820.

If the ramp voltage is linear with time, the time interval is proportional to the input voltage. If the ramp voltage is an exponentially decaying function of time, the time interval will be logarithmically related to the input voltage. Since the current in a series RC circuit is an exponential function of time for a step voltage applied to the series combination, a ramp-type DVM is ideal for logarithmic readout. As a matter of fact, it would be economically prohibitive to incorporate the logarithmic-readout feature of the 1820 in another type of DVM.

Figure 4 shows an oscilloscope of the linear and log sweeps of the 1820.

Input Circuits

One of the chief features of the 1820 is the high input impedance on all ranges, achieved through the use of a large negative feedback applied around the input amplifier.

In general:¹

$$Z_{fb} = Z_{in} \frac{1 - (A\beta)_{sc}}{1 - (A\beta)_{oc}}$$

where $(A\beta)_{sc}$ is the short-circuit loop gain and $(A\beta)_{oc}$ is the open-circuit loop gain. Since the loop gain with input terminals open is zero, the equation above is reduced to:

$$Z_{fb} = Z_{in} (1 - A\beta)_{sc}$$

In the 1820, the loop gain is approximately 80 dB on all but the 2-mV range (where it is 60 dB). Thus, if we take the 80-dB figure:

$$Z_{fb} = Z_{in} \times 10^4.$$

The input circuit in either plug-in is a full-wave photochopper operating at about 270 Hz. The impedance of the photochopper is about 500 MΩ in the -P1 and 50 MΩ in the -P2. Thus the typical input impedance is about 5×10^{12} ohms for the -P1 and 5×10^{11} ohms for the -P2 plug-in. Figure 5 shows the ac waveform at the output of the photochopper circuit in the -P1 with the feedback disconnected. It is interesting to note the fast rise and fall times of the chopped waveform at 270 Hz.

Output Amplifier

The output amplifier is capable of ±250 volts swing. This is necessary in order to maintain the high input impedance on all ranges, including the 220-volt range.

¹ T. S. Gray. *Applied Electronics*, Second Edition, John Wiley & Sons Inc., New York.

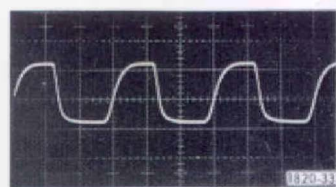
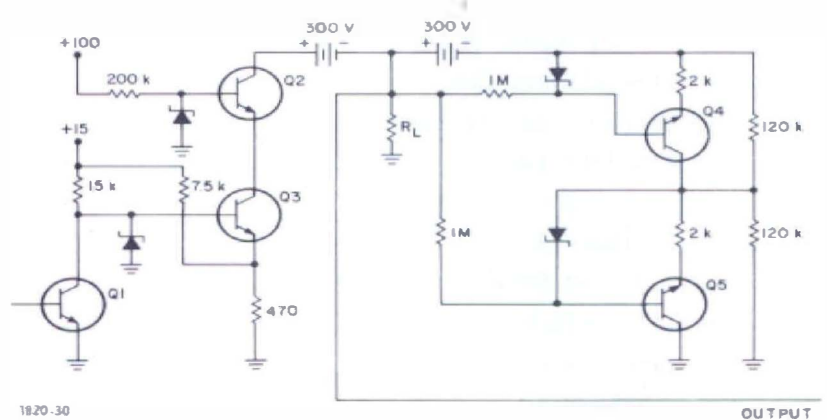

Figure 5. Ac waveform at photochopper output.

Figure 6. Simplified schematic diagram of the output amplifier.





K. George Balekdjian received his S.B. and M.S. degrees from M.I.T. He joined GR as a development engineer in 1964, and is presently a member of the Industrial Instruments Group. He is a member of IEEE, Tau Beta Pi, Eta Kappa Nu, and Sigma Xi.

Figure 6 is a simplified schematic diagram of the output amplifier. Transistors Q4 and Q5 are current sources capable of providing a 250-volt drop across the load resistor, R_L . Transistors Q2 and Q3 are current sinks which, when in the saturated state, will absorb the current supplied by transistors Q4 and Q5.

Transistor Q1 is the low-level control unit for the output amplifier. If this transistor is saturated, Q2 and Q3 are cut off, and all the current supplied by transistors Q4 and Q5 flows into the load resistor. On the other hand, if Q1 is cut off, Q2 and Q3 will be saturated and the voltage across R_L will be -300 volts less a small voltage drop from the collector of Q2 to ground.

UHF Probe

The 1820-P1 uses a uhf probe for measurements up to 1.5 GHz. Voltages up to 200 volts rms can be measured directly with this probe, although at frequencies above 500 MHz the maximum voltage is reduced somewhat. Physically, the probe is similar to that used in the GR 1806-A voltmeter,² but the linearizers to correct the response of the probe at different levels are more accurate.

²James J. Faran, Jr., "Higher Accuracy, Higher Frequencies with New Electronic Voltmeter," *General Radio Experimenter*, July 1963.

Resistance Measurements

The primary function of a DVM, of course, is to measure voltages. Some instruments, including the 1820, can also measure resistance and current by converting these quantities into voltages.

Currents are usually measured by means of a shunt resistor at the input terminals. The scheme used for resistance measurements is more complex and must involve some kind of current source at the input terminals.

There are two problems associated with high-value ($>10M\Omega$) resistance measurement with DVM's: (1) The input impedance may not be high enough on all ranges; (2) most transistor current sources become much less than ideal at these impedance levels.

Since the 1820 has at least 10^{11} ohms input impedance on all ranges, it easily meets the first requirement mentioned above. The following technique was used to overcome the limitations of transistor current sources (see Figure 7).

A constant-current source is obtained by means of a floating voltage source in series with a resistance in the feedback path. Since no current will flow in the error amplifier, the current, i , must flow through the unknown resistors, R_x . This will produce across the input terminals a voltage V_x that

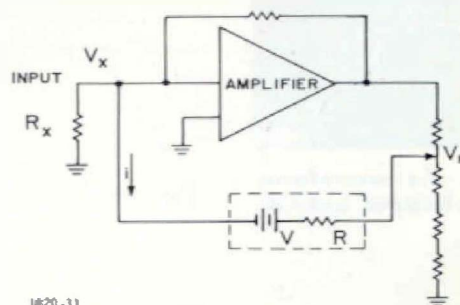

1820-31
Figure 7. Resistance-measurement technique with the 1820-P1.

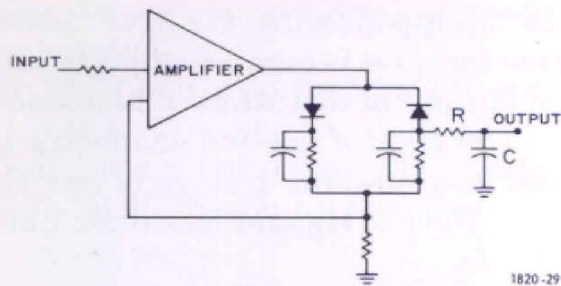

Figure 8. Basic circuit diagram of the operational rectifier of the 1820-P2.

will be equal to V_f by virtue of the high gain of the error amplifier. But, since current must flow through the range-setting resistors at the output of the error amplifier, a correction must be made for each range. One could measure resistors up to 200 megohms with the 1820-P1 if the maximum voltage across the unknown were not limited to 70 volts. Those wishing to measure resistors up to 200 megohms may disconnect the 70-volt limiter, provided that they can tolerate up to 200 volts across the input terminals.

The Average-Responding Detector

The 1820-P2 uses an operational rectifier to convert ac into dc. The detector is calibrated to read in terms of rms volts for sine waves. Figure 8 shows the basic circuit diagram for such a detector.

A simple passive RC filter will filter out the ac signal at the output without introducing long settling times. At low frequencies, the input-filter time constant may be increased by a front-panel control to reduce the ac component further.

Dc Differential Adaptor

It is often desirable to use a DVM in a bridge circuit or in a floating configuration. The common-mode voltages either at dc or power-line frequency

usually limit the accuracy of measurement in such situations. The problem is more severe as source impedances greater than 1000 ohms are encountered because of the unbalance between the high and low terminals of the instrument.

The 1820-P3 Dc Differential Adaptor (Figure 9) was designed specifically to improve the common-mode rejection for high-impedance-unbalance circuits. It plugs into either of the two plug-ins to convert the unbalanced input to a closely balanced differential input. This adaptor is actually a low-frequency (20-Hz) sample-and-hold device in which the sampling period is equal to the holding period. The input and output relays are timed so that one pair opens before the other pair closes. Thus the output is never in contact with the input terminal.



Figure 9. The 1820-P3 Dc Differential Adaptor, shown in place on the 1820-P2.

APPLICATIONS

Automatic Dc Leakage-Current Measurements

The 1820 can be used to make leakage-current measurements on capacitors, diodes, transistors, and other components. A typical capacitor leakage-current assembly is shown in the block diagram of Figure 10. In this system, a GR 1770 Scanner connects the components to the voltmeter serially. An external programmer activates a programmable power supply so that proper bias voltages are applied to the com-

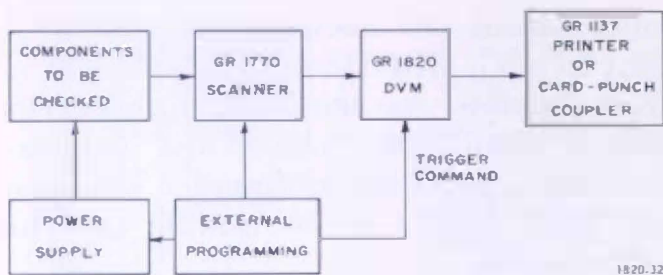

Figure 10. Typical system for measuring capacitor leakage current.

ponents. This programmer also determines the length of time necessary for the component to stabilize before a measurement can be made. After this time interval has elapsed, the programmer supplies a gate signal to the DVM to make the measurement. The 1820 with the -P2 plug-in is quite suitable for low-level leakage-current measurements, since the resolution on the most sensitive range is 1 picoampere. Automatic ranging of the 1820 will display the results within a fraction of a second, on the most appropriate range. A permanent record of results can be obtained with the GR 1137 data printer or a card-punch coupler. The standard data output of the 1820 is 1-2-4-2 BCD, convertible to 1-2-4-8 by a simple modification.

UHF Measurements

The small ceramic diode used in the ac probe has a very low inductance, resulting in a resonance frequency higher than 3000 MHz for the probe assembly. Very precise linearizers for each ac range give excellent linearity even down to 200 mV, one tenth of the most sensitive ac range.

For uhf measurements, the probe should be used in a closed coaxial system to avoid connection errors. The 1806-P1 Tee Connector is available as an accessory to replace the probe cap.

It is equipped with GR874[®] locking connectors and is compensated to introduce minimum disturbance in a smooth line. The SWR of the tee connector and probe in a 50-ohm system is less than 1.10 at 1000 MHz and less than 1.20 at 1.5 GHz.

Precision Ac Measurements

Precision ac measurements at frequencies up to 2 MHz are possible with the 1820-P2. The combination of this DVM and a GR 1310 oscillator is most effective for amplifier response testing. If a lower input capacitance is desired, a Tektronix 10:1 oscilloscope probe can be used directly with the 1820. Also, ac currents can be measured with a Tektronix Type 6020 Current Probe and an adaptor supplied with the -P2 plug-in.

With its 1- μ V sensitivity, the 1820 can be used for many measurements that could not before have been handled by a DVM, at least not without external amplifiers. The decibel readout should also prove most useful for many amplifier-response measurements.

Resistance Measurements

As described earlier, the 1820 uses an unusual method of resistance measurement, which allows the user to measure resistances up to 50 megohms without degradation of accuracy.

The 1820 is also useful in resistance measurements on integrated circuits, where the applied voltage must be limited to about 5 volts. The 1820 with either plug-in will measure resistance up to 2 megohms with a maximum of 2 volts applied to the device. A 4-volt Zener diode at the input terminals of the 1820 will prevent any damage to the circuit under test from accidental range changing of the DVM. If a GR 1770

Scanner is added, the test procedure can be automated.

The 1820 can also be used in automatic test setups for resistance sorting. One can measure resistances from 2.000 ohms to 20.00 megohms full-scale with

the 1820-P2 automatically and without any external circuitry. With the -P1 plug-in, resistors up to 200 megohms can be measured, with no degradation in accuracy.

— K. G. BALEKDJIAN

<i>Catalog Number</i>	<i>Description</i>	<i>Price in USA</i>
1820-9700	1820-A Digital Voltmeter (no plug-in)	\$1985.00
1820-9701	Bench model	1985.00
	Rack model	
	Plug-ins and Accessories	
1820-9601	1820-P1 DC Multimeter/UHF Voltmeter	525.00
1820-9602	1820-P2 AC/DC Millivoltmeter	550.00
1820-9603	1820-P3 Differential Adaptor (for use with 1820-P1 or -P2 plug-in)	90.00
1806-9601	1806-P1 Tee Connector	40.00

Detailed specifications on the 1820 Digital Voltmeter appear in General Radio Catalog T

THE UNIVERSAL IMPEDANCE BRIDGE— NEW FACE, NEW FEATURES

Type 1650-B Impedance Bridge.



One of the truly basic laboratory instruments, along with the voltmeter and the oscilloscope, is the impedance bridge. Although there is a great variety of impedance bridges, by far the most popular is the general-purpose type that combines several bridges in

one package to permit quick, convenient, reasonably accurate measurements of resistors, capacitors, and inductors.

The grandfather of this class of instrument was GR's TYPE 650 Impedance Bridge, succeeded about a decade

ago by the 1650. The 1650, with its own generator, detector, and battery power supply, a basic 1% accuracy from 20 Hz to 20 kHz, an Orthonull[®] balancing mechanism that eliminated sliding balance, and a Flip-Tilt carrying case, soon won an excellent reputation on its own merits, even among a new generation that had never heard of the 650.

The next chapter in the story will be written by the 1650-B, which now replaces the 1650-A. A number of important improvements lie behind the change in letter suffix; despite this fact, it has been possible to reduce the price of the bridge.

The 1650-B offers all the features of the 1650-A plus the following:

1. A conductance bridge, which offers direct micromho readout and extends the range of resistance measurements to 1000 megohms.

2. A slow-motion mechanism on the CGRL dial, which automatically comes into play over a narrow sector each time the direction of rotation is reversed. The effect is a considerable improvement in operating convenience.

3. White sectors on the balance dials to indicate the ranges where the Orthonull balancing mechanism should be switched in for quickest, easiest balance.

4. A battery-check switch position and a corresponding sector on the meter scale.

5. Improved internal dc sensitivity for low-value resistors.

6. Provision for use of an external resistance decade box to extend the DQ range.

7. Access to the bridge arm opposite the unknown arm, so that an external capacitor can be added to obtain a

reactance balance of inductive resistors.

8. Relocation of all jacks and terminals except the "unknown" terminals to a side panel, out of the way of the operator.

9. Automatic closure of the BIAS and EXT DQ phone jacks when they are not in use, so that one doesn't have to check the connection of shorting links between binding posts.

10. A redesigned bridge transformer, requiring less drive power at low frequencies.

"Who needs a conductance bridge, anyway?" Because the 1650 is used chiefly to measure components, not including conductors as such, this question will inevitably be asked. Answering it also gives us the chance to discuss the usefulness of ac resistance measurements, possible with the 1650 but not with some other "universal" impedance bridges. Here are just a few of the things you can do with ac resistance and conductance measurements.

Equivalent-Circuit Determinations

When developing an equivalent circuit of an unknown, one usually measures the reactive part on the 1% CRL dial and calculates the resistive part using a DQ measurement, which is only 5% accurate. With ac-resistance capability one can measure the resistive part to 1% and calculate the reactive part using the value of an external capacitor (Figure 1). Use of both methods leads to the most accurate determination of the equivalent circuit.

Impedance Measurements on Batteries

To measure the impedance of a battery, one has only to insert a blocking capacitor in the bridge's bias jack to

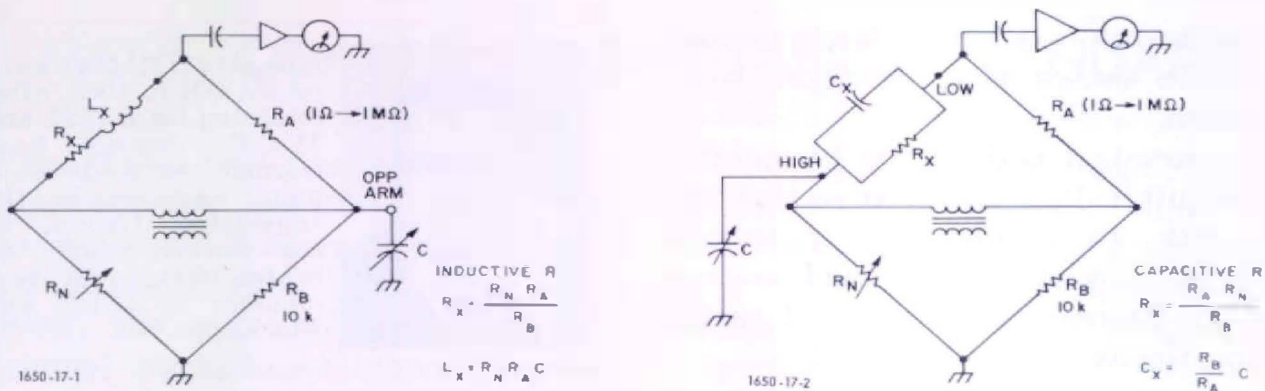

Figure 1. Diagrams showing use of the ac-resistance bridge to make reactive balances.

prevent the flow of large currents through the ratio arm (Figure 2). It is easy to tell sintered-plate (low resistance) and pocket-plate (higher resistance) nickel-cadmium batteries apart by the difference in resistance. The resistance is also a function of the batteries' state of charge. The short-

supplies and Zener diodes) with dc voltage present.

Input Impedance of Transistor Amplifiers and Other Active Circuits

The 1650-B can be used to determine the input impedance of transistor amplifiers and other active circuits. Consider the bootstrapped emitter-follower circuit of Figure 3a. The ac input resistance is measured and found to be about 760 kilohms, but the null is not sharp, indicating a large reactive component. A capacitor inserted between the OPP ARM jack and the case improves the balance, indicating that the input impedance is inductive. Finally, measurement on the series inductance bridge, with Orthonull, yields an inductance value of 4.92 henrys and a Q of 0.041, which corresponds to a series resistance of 755 kilohms, agreeing with the ac resistance measurement. Knowledge like this is invaluable in explaining the behavior that results when this ampli-

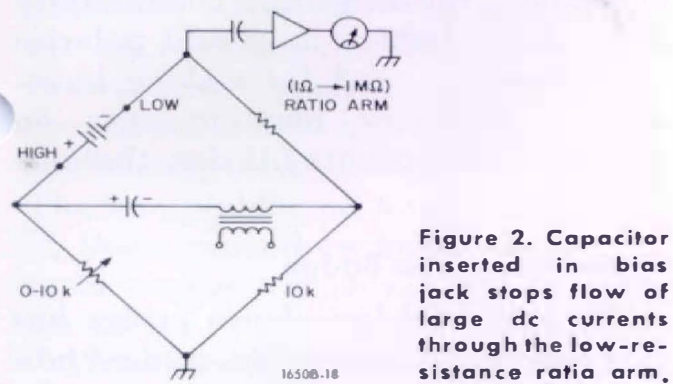

Figure 2. Capacitor inserted in bias jack stops flow of large dc currents through the low-resistance ratio arm.

circuit current of the cell is accurately predicted by the resistance measurement $I_{cell} = \frac{V_{cell}}{R_{ie}}$. This technique is valuable for measuring many low impedances (e.g., simple regulated power

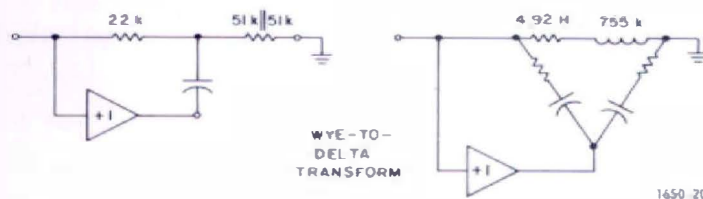
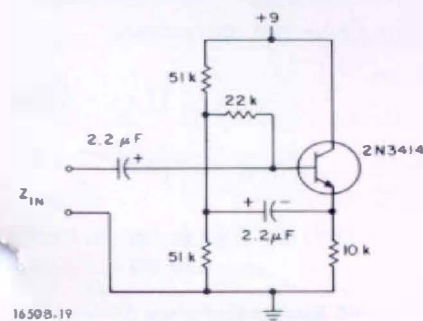

Figure 3a (left). Bridge can be used to determine input impedance of transistor amplifiers such as the bootstrapped emitter follower shown here. Figure 3b (right). A redrawing of the circuit of Figure 3a, showing why the input appears inductive.

fier is incorporated in a large circuit. Figure 3b shows why the input looks inductive.

In general, it is desirable to monitor the output voltage from an active circuit with an oscilloscope to ensure linearity. The oscillator level control can be decreased to prevent overdriving the active circuit.

Measurement of Transistor h Parameters

All the complex hybrid parameters of a transistor for the equivalent circuit of Figure 4 can be measured with a 1650-B and an easily constructed test jig. The hybrid π model is in vogue these days, but its parameters are calculated in part from h_{ie} , h_{oe} , h_{fe} , and h_{re} ; it is thus still necessary to measure these h parameters. The four-terminal parameters, h_{re} and h_{fe} , must be calculated from impedance values measured with the base ac-shorted to the collector or the emitter. This all may sound a little troublesome, but in practice the measurements go very smoothly. (Further details will appear in a future issue of the *Experimenter*.)

These measurements have proved quite accurate as verified by comparison with measurements made on other testers and by a computer simulation of an

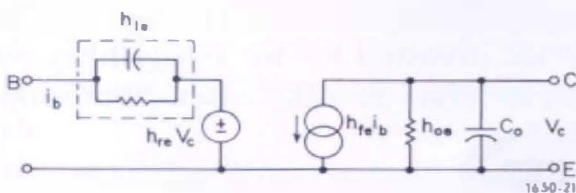

Figure 4. h-parameter equivalent circuit of a transistor.



Charles D. Havener joined GR in 1965, after receiving his B.E.E. and M.E.E. degrees from Cornell. As a development engineer in the Impedance Group, he has worked chiefly on bridge design. He is a member of IEEE and Eta Kappa Nu.

amplifier designed to emphasize the measured h parameters. The computed frequency response agreed with that measured within a few dB to 100 kHz when the capacitance in parallel with h_{ie} was included in the model.

Ac resistance measurements are also useful for determining the approximate magnitude of a completely unknown impedance, for measuring conductivity of solutions (where dc would polarize the electrodes), and for making incremental resistance measurements on nonlinear components (diodes, thermistors, etc).

Student Use of the Bridge

The universal impedance bridge has long been a mainstay of the student laboratory. In recognition of this fact, the latest in our series of Student-Experiment pamphlets is devoted entirely to the use of the 1650-B by students. Publication STX-107, "The Universal Impedance Bridge," discusses the principle and techniques of bridge measurement and includes some suggested student experiments. It is free on request.

— C. HAVENER

Catalog Number	Description	Price in USA
1650-9702	1650-B Impedance Bridge Portable model	\$450.00
1650-9703	Rack model	450.00

Detailed specifications on the 1650-B Impedance Bridge appear in General Radio Catalog T

MORE COAXIAL CAPACITANCE STANDARDS

The TYPE 1406 two-terminal capacitance standard¹ has been joined by two new series: the lower-valued TYPE 1405 and the higher-valued TYPE 1407. Altogether, the range of values for two-terminal capacitance standards using precision coaxial connectors now extends from 1 pF to 0.1 μ F.

In the 1405 and 1407 standards, as in the 1406, the combination of the GR900[®] precision coaxial connector and careful capacitor design and fabrication results in significantly improved performance up into the rf range. The high repeatability, low inductance, and precisely known reference plane of the connector effectively eliminate one of the chief problems in the calibration of two-terminal capacitance standards — the variation in stray capacitance from one binding-post connection to another. The low, stable and known inductance of these capacitors keeps the capacitance change with frequency at a very low value.

Two-terminal capacitance standards usually are calibrated in terms of the capacitance added to the bridge terminals. When the terminals of the bridge and of the standard are binding posts, the capacitance added by the standard is not clearly defined. Connecting the standard changes the stray capacitance between the bridge binding posts and also adds stray capacitance from the capacitor case to its own binding posts. The fact that no two binding-post pairs have exactly the same configuration adds to the problem as the standard is connected to various instruments.

¹R. W. Orr, "Capacitance Standards with Precision Connectors," *General Radio Experimenter*, September 1967.

The use of a GR900 precision connector for both bridge and standard terminals changes all this. The connector has a precisely known reference plane, which separates bridge and standard capacitances. Bridge capacitance can be defined and measured as the internal capacitance on one side of this reference plane, and the capacitance of the standard is the total capacitance on the other side.

The result of using the coaxial connector is a reduction in error due to stray capacitance of almost two orders of magnitude over open, two-terminal standards at rf frequencies. The new two-terminal capacitors thus approach the reproducibility found before only with three-terminal capacitance standards at the lower frequencies.

1406 Series Standards

The 1406 series of capacitance standards, described in an earlier *Experi-*

Capacitance values available in the 1405, 1406, and 1407 series coaxial capacitance standards

Series	Type	Capacitance
1405	E	1 pF
	D	2 pF
	C	5 pF
1406	E	50 pF
	D	100 pF
	C	200 pF
	B	500 pF
	A	1000 pF
1407	A	0.001 μ F
	B	0.002 μ F
	C	0.005 μ F
	D	0.01 μ F
	E	0.02 μ F
	F	0.05 μ F
	G	0.1 μ F

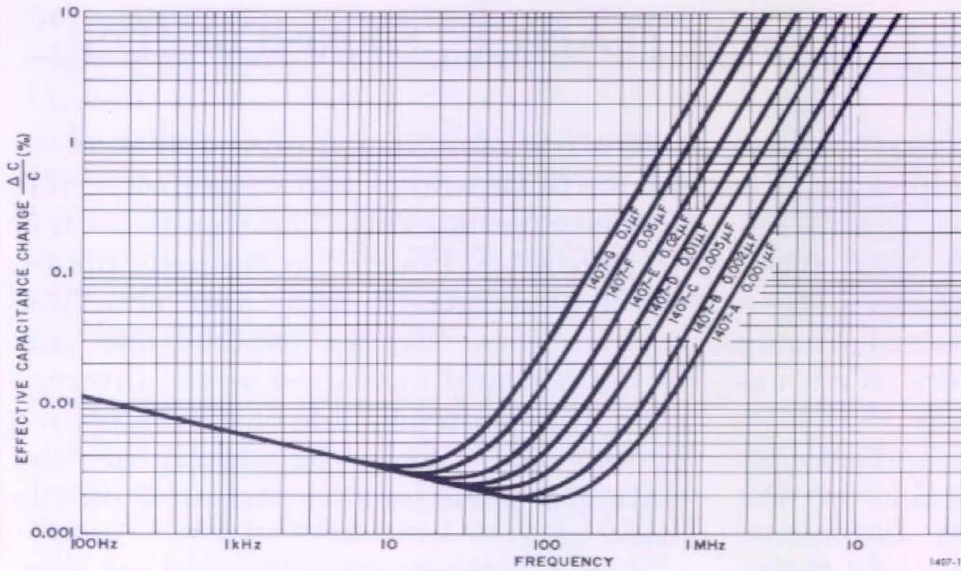

Figure 1. Capacitance-vs-frequency characteristics of the 1407 capacitors.

menter¹, include fine standard capacitors, from 50 to 1000 pF. To these are now added seven TYPE 1407 standards, in values from 0.001 to 0.1 μ F, and three 1405 units, in values of 1, 2, and 5 pF.

Type 1407

The TYPE 1407 capacitor consists of a silvered-mica and foil stack which is clamped under heavy spring pressure for mechanical stability. This internal structure is similar to that used in the GR TYPE 1409 standard capacitor, whose stability has been proven over the past decade.

The mica is selected for low dissipation factor. Short, heavy conductors connect the capacitor to the GR900 connector mounted on the top plate of the case, resulting in minimum inductance. The aluminum case is sealed, with a port provided for testing the case under vacuum for leaks. Capsules of silica gel inside the case provide continuous desiccation.

Sealing the mica capacitor in the case with a desiccant makes it possible

to reduce the insulating material, other than mica, to a minimum. The only insulation except mica and dry air is a Teflon bead in the GR900 connector and a small amount of low-loss rubber in the gasket sealing the connector. This, together with the high quality of the mica, makes it possible to keep the capacitance changes caused by temperature and interfacial polarization to a minimum.

In the 1407 series, interfacial polarization in the mica dielectric is a source of capacitance change with frequency at the lower frequencies (see Figure 1). Careful choice of and drying of the mica and the elimination of practically all other insulation keep this effect at a

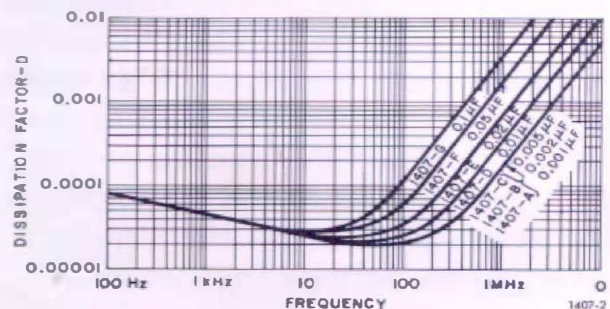

Figure 2. Dissipation-factor-vs-frequency characteristics of the 1407 capacitors.

¹ *Ibid.*

minimum, but there is still a slight increase in effective capacitance below 100 kHz.

At low frequencies (see Figure 2), the dissipation factor also is largely determined by interfacial polarization in the mica dielectric. At higher frequencies, the dominant losses result from the resistance of the metallic conductors. Above 100 kHz, the dissipation factor is approximately proportional to the $3/2$ power of the frequency, because of skin effect.

Type 1405

Each of the TYPE 1405 capacitors comprises a section of coaxial line (with inner conductor built up in diameter for the 2-pF and 5-pF units), cantilevered from a PPO (polyphenylene oxide) support rod. The PPO has excellent physical stability and a silicone coating greatly reduces the effects of changes in humidity.

The PPO support contains a threaded PPO cylinder used at the factory for trimming the capacitance to the exact value. A simple residual inductance

value is not given for the 1405 because of the distributed nature of the capacitance in this construction.

The capacitance in this 1405 series maintains its dc value to very high frequencies (see Figure 3) and changes thereafter so little that these capacitors are useful in the calibration of measuring instruments well into the uhf region. A 1405 also can serve as a low-capacitance terminating or support means for any two-port device.

Calibration Certificate

A calibration certificate supplied with each capacitor gives the measured value of capacitance at 1 kHz and the temperature and relative humidity at the time of measurement. The calculated effective capacitance of the unit at a higher frequency, such as 1 MHz, also is supplied with some units. The calibrations apply at the well-defined reference plane of the GR900 connector. The 1-kHz capacitance is obtained by comparison with working standards whose absolute values are known to an accuracy of $\pm 0.01\%$.

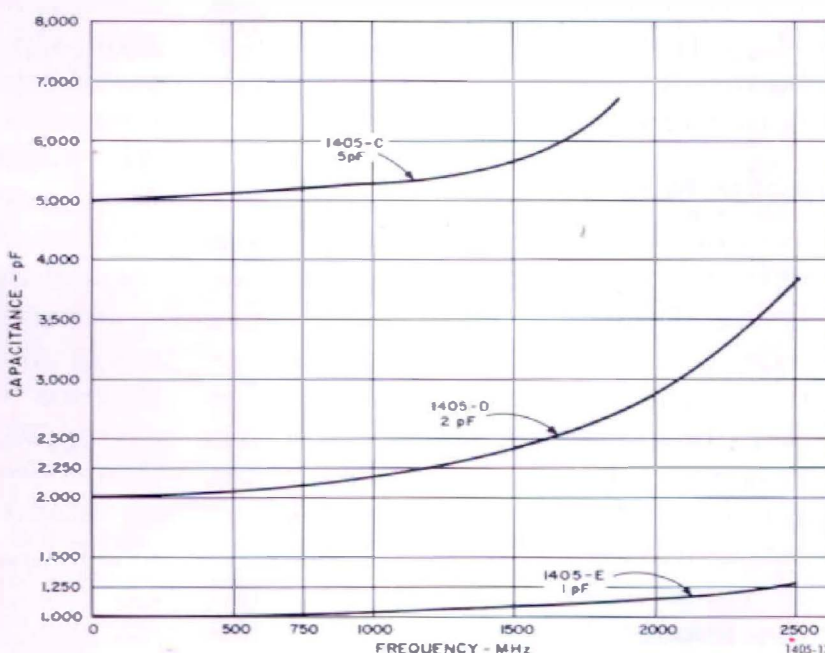

Figure 3. Capacitance-vs-frequency characteristics of 1405 capacitors.

The stability of these capacitance standards permits them to be monitored quite conveniently at 1 kHz to make certain that changes have not occurred over any of the frequency range. The very small capacitance changes that may occur due to normal aging will be the same at all frequencies. Changes in inductance are more serious at the high frequencies. The internal construction is very rugged, however, and any treatment likely to affect the inductance will show up as low-frequency capacitance changes or as obvious damage to the capacitor.

High-precision measurements can be made readily at 1 kHz using any of a number of bridges, such as the TYPE 1620-A, while high-precision measurements at 1 MHz can be made at only a few places outside of NBS. Repeated measurements at 1 MHz are not necessary, owing to the low inductance and the rugged construction of the standard. The fact that any change in its 1-MHz capacitance value will be accompanied by a proportional change in its 1-kHz capacitance value permits a standard to be NBS-calibrated at 1 MHz, and this high-frequency value thereafter can be monitored by means of periodic 1-kHz measurements.

Application Notes

Any open connector, including the GR900, has a fringing capacitance consisting of the total stray capacitance between its terminals. When a capacitor with a GR900 connector is coupled to another GR900 on an instrument, all fringing capacitance is eliminated. The joined connectors act as a straight section of coaxial line.

The value of capacitance calibrated for the standard is the value of the

capacitor up to the precise reference plane provided by its connector.

The use of a GR900 precision connector for the instrument terminals provides a precisely known reference plane for the instrument also. Its internal capacitance can be defined as the internal capacitance up to this reference plane. However, an open GR900 connector on an instrument has a fringing capacitance beyond its reference plane. When a capacitor with a GR900 connector is added to the open instrument connector, the net increase in capacitance equals the value of the capacitor, as measured at its reference plane, minus the fringing capacitance of the instrument connector. This fringing capacitance can be anticipated approximately,* but even better accuracy can be obtained if an initial balance is made with a small capacitor whose value is known precisely at its reference plane.

The small capacitance of the 1405-E 1-pF unit, for example, provides the means for eliminating, accurately, this fringing capacitance in the initial setting of a bridge or for setting up an accurate reference plane. This same unit also provides a low-capacitance termination for supporting the inner conductor of the 900-LZ Reference Air Lines. These air lines also are terminated with a GR900 precision connector and can serve as accurate capacitance standards up to 20 pF.

Because of their wide frequency range and acceptance by the National Bureau of Standards for calibration above 30 kHz, these capacitance standards are expected to be used chiefly as standards for the calibration of

* The fringing capacitance of an open GR900 connector is 0.155 ± 0.008 pF in the usual environment on a bridge with no conductors within several inches of the open connector, and 0.172 ± 0.008 pF with a 900-W Open-Circuit Termination.

two-terminal bridges and other impedance-measuring instruments. Of course, the most convenient arrangement and the most accurate measurements will result when a bridge is equipped with a GR900 connector.

The next best thing is a precision adaptor, and two of these have been designed specifically for use with bridges. One, the TYPE 1615-P2, is used with the 0.01%, 1-kHz TYPE 1615-A Capacitance Bridge. A trimmer capacitor is included so that the terminal capacitance can be effectively eliminated from the measurement.

The TYPE 900-Q9 Adaptor mates with binding posts on $\frac{3}{4}$ -inch spacing, such as those used on the GR716 Capacitance Bridges, with other posts with a $\frac{1}{4}$ -28 thread, or with tapped holes on $\frac{3}{4}$ -to-1-inch spacing. Among the many instruments accommodated are the Boonton Radio Type 260A Q Meter and the Boonton Electronics Model 75 Capacitance Bridge.

— R. ORR
J. ZORZY

Brief biographies of Mr. Orr and Mr. Zorzy appeared in the August, 1966 *Experimenter*.

SPECIFICATIONS FOR TYPE 1407

Calibration: A certificate of calibration is supplied with each unit giving the measured capacitance at 1 kHz and at a specified temperature. The measured value is the capacitance at the reference plane of the GR900 connector. This value is obtained by comparison to a precision better than $\pm 0.005\%$ with working standards whose absolute values are known to an accuracy typically $\pm 0.01\%$, determined and maintained in terms of reference standards periodically calibrated by the National Bureau of Standards.

Stability: The capacitance change is less than 0.01% per year.

Accuracy: Within $\pm 0.05\%$, at 1 kHz, of the nominal capacitance value marked on the case.

Temperature Coefficient of Capacitance: $+20 \pm 10$ ppm/ $^{\circ}\text{C}$, between 10 and 70 $^{\circ}\text{C}$.

Dissipation Factor: 50×10^{-6} typical at 1 kHz and 23 $^{\circ}\text{C}$. Max values given in table below; see

Figure 2 for D vs frequency. Measured D at 1 kHz is stated in certificate to an accuracy of ± 0.00005 .

Series Inductance: 7 nH typical.

Frequency Characteristics: See Figures 1 and 2.

Insulation Resistance: Minimum of 5000 ohm-farads or 100 G Ω , whichever is the lesser, when measured at 500 V dc after two minutes electrification.

Max Voltage: 500 V pk.

Accessories Available: Adaptors 1615-P2 for convenience in calibrating with the 1615-A Capacitance Bridge and 900-Q9 for connecting 1407 to $\frac{1}{2}$ -in. x 28 threaded stud (GR 938 Binding Post) or tapped hole.

Terminal: GR900 precision coaxial connector.

Mounting: Aluminum panel and cylindrical case.

Dimensions (dia x ht): 3 x 4 $\frac{3}{4}$ in. (77 x 125 mm).

Weight: Net, 1 $\frac{1}{4}$ lb (0.6 kg); shipping, 4 lb (1.9 kg).

Catalog Number	Type	Nominal Capacitance	Max D at 1kHz and 23 $^{\circ}\text{C}$	Price in USA
1407-9700	1407-A	0.001 μF	0.00030	\$ 85.00
1407-9701	1407-B	0.002 μF	0.00025 ¹	95.00
1407-9702	1407-C	0.005 μF	0.0002	95.00
1407-9703	1407-D	0.01 μF	0.0002	95.00
1407-9704	1407-E	0.02 μF	0.0002	100.00
1407-9705	1407-F	0.05 μF	0.0002	115.00
1407-9706	1407-G	0.1 μF	0.0002	115.00

Detailed Specifications on the Type 1405 Coaxial Capacitance Standards appear in General Radio Catalog T

Catalog Number	Type	Nominal Capacitance	Accuracy	Peak Volts	Frequency for 10% C Increase	Price in USA
1405-9702	1405-C	5 pF	± 0.010 pF	1 kV	0.75 GHz	\$55.00
1405-9701	1405-D	2 pF	± 0.005 pF	1 kV	1.0 GHz	55.00
1405-9700	1405-E	1 pF	± 0.005 pF	3 kV	1.7 GHz	55.00

the  Experimententer

GENERAL RADIO COMPANY
WEST CONCORD, MASSACHUSETTS 01781

GENERAL RADIO COMPANY

WEST CONCORD, MASSACHUSETTS 01781

SALES AND SERVICE

Area	Telephone
Albuquerque	505 255-0611
*Boston	617 646-0550
*Chicago	312 992-0800
Cleveland	216 886-0150
Bridgeport	203 377-0165
*Dallas	214 ME7-2240
Dayton	513 434-6979
Denver	303 447-9225
Detroit	313 261-1750
Houston	713 622-7007
Huntsville	205 883-2077
Indianapolis	317 636-3907
*Los Angeles	213 469-6201
Montreal	514 737-3673
New Haven	203 377-0165
*New York	(NY) 212 964-2722 (NJ) 201 943-3140
Orlando	305 425-4671
Ottawa	613 233-4237
Philadelphia	215 646-8030
San Diego	714 232-2727
San Francisco	415 948-8233
Seattle	206 GL4-7545
Syracuse	315 454-9323
*Toronto	416 247-2171
*Washington/Baltimore	301 946-1600

*Repair services are available at these offices.

GENERAL RADIO COMPANY (OVERSEAS)
CH 8034 Zürich 34, Switzerland

GENERAL RADIO GMBH
DB München 80, West Germany

GENERAL RADIO COMPANY (U.K.) LIMITED
Bourne End Buckinghamshire, England

REPRESENTATIVES IN PRINCIPAL
OVERSEAS COUNTRIES

PRINTED
IN
U.S.A.

Do we have your correct name and address—name, company or organization, department, street or P.O. box, city, state, and zip code? If not, please clip the address label on this issue and return it to us with corrections, or if you prefer, write us; a postcard will do.